

Ambiductor HEAT 1

Compact energy meter with ultrasonic technology

Operating and mounting instructions, owners manual

Applications

Energy measurement of heating and/or cooling in district heating, heat pump or secondary heating.

Table of contents

General information	2	Technical data	15
Principle of operation	2	Flow measurement	15
Security	2	Temperature limits for the liquid	15
Warranty	2	Temperature measurement	15
Transport and storage	2	LCD Display	15
Installation instructions	3	Register and data logger	16
Basic requirements	3	Data logger capacity	16
Mounting	3	Mechanical data	16
Mounting of flow sensors	3	Environmental conditions	16
Mounting of temperature sensors	3	Pressure drop	16
Mounting of energy calculator	3	Accuracy	16
Jumpers J setting	4	Power supply	17
Checking installation & configuration	4	Internal battery	17
Sealing after installation	4	24V module	17
Electrical installation	4	230V unit (external)	17
Temperature sensor connection	4	Remote reading	17
Connection of the customer's temperature sensor	4	Optical interface	17
Installation of additional communication modules	4	M-bus	17
External power supply	4	Lora	17
Operating instructions	5	Pulse outputs	17
Screen Features	5	Pulse inputs	17
Flow symbols	5	Bus communication limitation	17
Menu structure	5	Marking and sealing	18
User menu in normal mode	5	Marking	18
Menu	5	The calculator	18
Test/verification mode	12	Flow sensors	18
Menu	12	Sealing	18
Connections in the test / verification mode	13	The seal of the manufacturer	18
Exit test / validation mode	13	Valideringsplombering	18
Verification	13	Monteringsplombering	18
Overflow	13	Sealing of calculator	18
Info codes / alarms	14	Seals on flow sensors	18
		Seals on temp sensor PL (dip tube)	18
		Seals on temp sensor DS (direct)	18
		Dimensions and connections	19

NOTE!

The meter has a limited reading via bus when it is powered by battery. Supplement with external voltage supply 24 / 230V and go to www.ambiductor.se/support for instructions.



General information

Energy measurement of heat and/or cooling for both the primary side of district heating and distribution measurement on the secondary side. Certified according to MID for billing.

It is approved for billing the energy consumption in local or district heating systems: in residential buildings, office buildings or energy plants and the like.

The meter can be mounted in both the forward and return pipes (with the correct programming).

The meter comes with paired temperature sensors, pre-installed at the factory. The user can also use other paired temperature sensors that meet the requirements of Directive 2004/22/EC on metering instruments on March 31, 2004 and which have type approval.

The heat meter meet the basic requirements of the Technical Regulation Measuring Instruments, dated March 30, 2006 (transposition into the NB Directive 2004/22 / EC of 31 March 2004 on measuring instruments):

Appendix I Basic requirements

Appendix MI-004 Thermal heat meter,

HEAT 1 complies with the European standard EN 1434 "Thermal heat meter" parts 1 + 6.

HEAT 1 complies with the "C" class environmental protection requirements according to EN1434-1: 2007

Ambient temperature: from +5° C to 55°C,

Mechanical environmental class: M1,

Electromagnetic environmental class: E2.

NOTE! The meter is a precision instrument and must be treated as such during installation. Faulty handling can lead to termination of the warranty. Use brass couplings to connect the meter.

Principle of operation

The flow measurement is based on the ultrasound measurement method. The ultrasonic signal in the flow directions moves many times faster than against the flow. The ultrasonic sensors must perform both transmitter and receiver functions. From the resulting time difference, the flow rate is calculated.

The liquid temperature is measured with standard platinum resistance temperature sensor Pt500. Paired temperature sensors with 2-wire connection for measuring temperatures in the supply and return pipes are used. Flow and return temperature sensors can only be replaced in pairs.

Energy Calculation Formulas:

Flow sensor in supply line

$$Q = V1 * \rho1 * (h_{T1} - h_{T2})$$

Flow sensor in the return line

$$Q = V1 * \rho2 * (h_{T1} - h_{T2})$$

Explanation of abbreviations:

Q = thermal energy

V1 = Water volume, m³

$\rho1$ $\rho2$ = Water densities, according to supply and return water temperatures $\theta1$, $\theta2$

h_{T1} , h_{T2} - Enthalpies, according to water temperatures $\theta1$, $\theta2$

When the cooling function is activated by reversed temperature difference, the cooling energy will be registered in the extra register:

$$\Sigma Q = Q1 + Q2$$

Flow sensor in flow line

When $\theta1 > \theta2$: $Q1 = V1 * \rho1 * (h_{T1} - h_{T2})$; $Q2 = 0$

When $\theta1 < \theta2$: $Q2 = V1 * \rho1 * (h_{T2} - h_{T1})$; $Q1 = 0$

Flow sensor in return line

When $\theta1 > \theta2$: $Q1 = V1 * \rho2 * (h_{T1} - h_{T2})$; $Q2 = 0$

When $\theta1 < \theta2$: $Q2 = V1 * \rho2 * (h_{T2} - h_{T1})$; $Q1 = 0$

The Integration Agency performs all necessary measuring and data storage functions.

Security

The meter is powered from the battery (3.6 V) or 230V.

During the installation and service of the meter, heat-bearing fluid can flow through the flow sensor with static pressure up to 1.6 MPa and temperatures up to 180 °C.

Only qualified technical personnel can install and maintain heat meters. Staff must be familiar with appropriate technical documents and general safety regulations. It is necessary to observe the general safety requirements during installation and maintenance process.

Unit meets safety class II. Protective grounding is not required, since the casing is made of plastic, and the conductive parts are not exposed to the surface. Safety guarantees when installing and servicing the meter are:

- Reliable electrical circuit insulation,
- Hermetic installation of the primary flow and temperature sensor in the pipeline,
- Reliable attachment of sub-units by heat meters during installation. Safety requirements for temperature sensors can be found in the appropriate technical documentation.

Warning! Mounting of the different parts of the meter is only permitted after ensuring the absence of heat-bearing fluid in the pipeline.

NOTE! Work with high-voltage circuits may only be done by authorized personnel.

NOTE! Work with pipe systems may only be done by authorized personnel.

Warranty

The manufacturer guarantee that the equipment meets the stated technical requirements, provided that transport, storage and operating conditions are followed.

Transport and storage

Requirements for safe transport and storage regarding temperature, pressure and humidity can be found in Technical data below.

Packed equipment may be transported in all types of covered vehicles. Equipment must be anchored in a reliable manner to avoid shocks etc.

Equipment must be protected against mechanical damage and shock.

Equipment must be stored dry in heated rooms, where the ambient temperature is not less than + 5 °C. No aggressive chemical substances should be stored together due to risk of corrosion.

Installation instructions

Basic requirements

Heat meters are intended for installation in heating or combined heating and cooling systems.

Before installing the device:

1. Make sure all parts listed in the documentation are available
2. Check for any visible mechanical defects
3. Check if there are valid labels by the manufacturer and the certification authority

Only qualified personnel may install the equipment, and must comply with the requirements set forth in this document in the technical documentation for other system components.

It is prohibited to mount signal cables less than 5 cm from power cables and cables to other devices.

It is forbidden to change the length of any cable.

Mounting

Mounting of flow sensors

Sizes and fittings of the flow sensor are available in Dimensions and connections.

Up to DN50 there are no requirements for straight pipes for installation. From DN65, 5xDN applies upstream, 3xDN downstream. Avoid flow meter installation close to pumps that can cause cavitation.

Flow sensors can be mounted both vertically and horizontally in pipelines. Vertical mounting of the flow sensor is permitted only if the flow direction in the pipeline is upwards.

The direction of the flow sensor (indicated by the arrow below the flow sensor) must match the flow direction in the pipe.

The connection gasket must match the pipe diameter. During installation, the gasket must be precisely centered with the center of the pipe cross section to avoid sticking gaskets inside the pipe.

NOTE! Flow sensors must be mounted between shut-off valves to enable validation/calibration and simplify service.

Mounting of temperature sensors

Temperature sensors are mounted perpendicular to the pipe or inclined at a 45° angle to the liquid flow direction so that the sensor element has been inserted close to the center of the pipe (see Marking and sealing).

In G20 / G $\frac{3}{4}$ "and G25 / G1 meters, a temperature sensor is pre-mounted in the flow sensor.

Mounting of energy calculator

Energy calculators can be installed in heated premises, ambient temperature should be max +55 °C. It should not be exposed to direct sunlight.

For liquids outside +10 ... 90 °, the calculator should NOT be mounted on the flow sensor.

The calculator can easily be mounted on the wall thanks to DIN rail mounting.

The cable between the calculator and the flow sensor is normally 1.2m (can be ordered 2.5 and 5.0m).

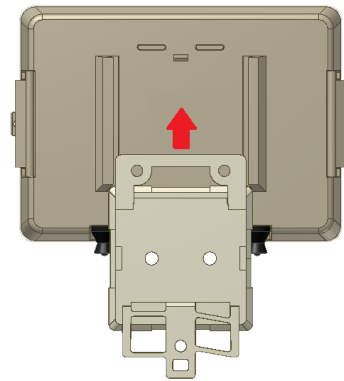

Mounting on standard DIN rail

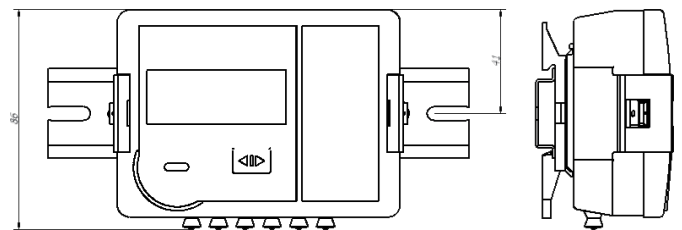
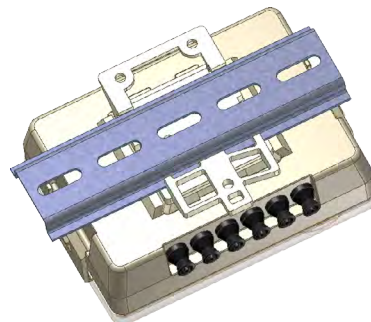

Mounting on adapter plate according to figure 8 in EN1434-2: 2007 for wall mounting of calculator can be used (if the opening in the wall is too large for the calculator)

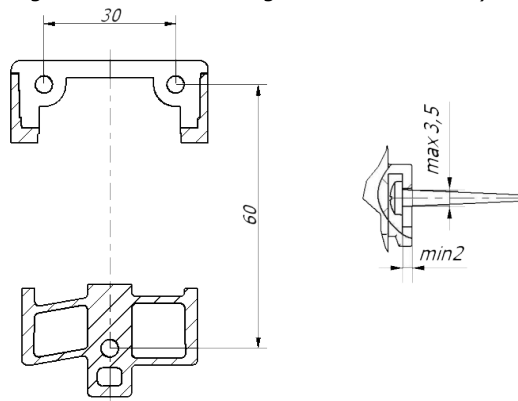

Direct mounting on the ultrasonic flow sensor rotatable for every 90 ° (only allowed when the temperature of the liquid does not exceed 90 °C):

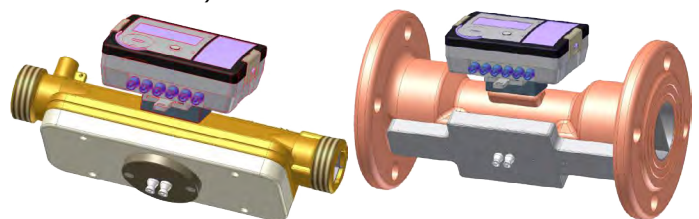

Important: It is forbidden to attach the calculator directly to a wall with a risk of condensation or temperatures below +5 °C. Then it is recommended to attach the calculator with an air gap of at least 5 cm.

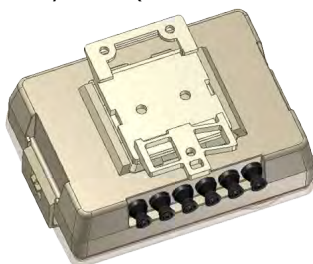

Jumpers J setting

The connector J is located in the integrator between the connection terminals of the temperature sensors and the pulses / outputs (see below). By using or not using jumpers on this connector, one can enter / exit test mode and select pulse inputs or outputs:

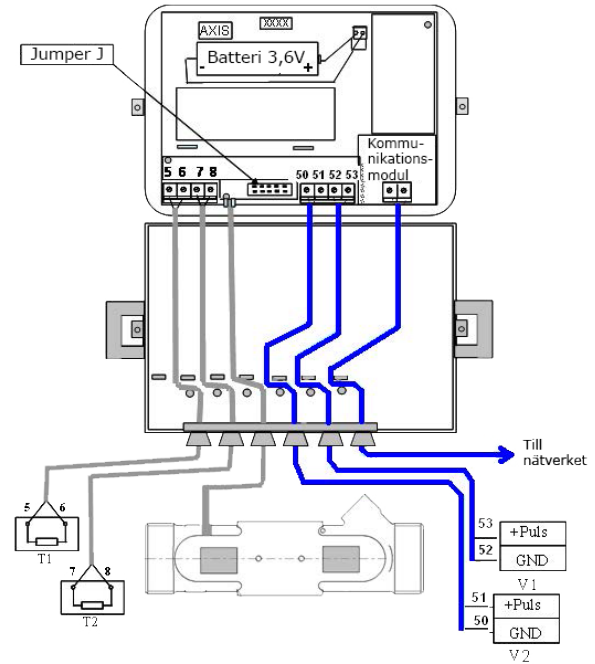
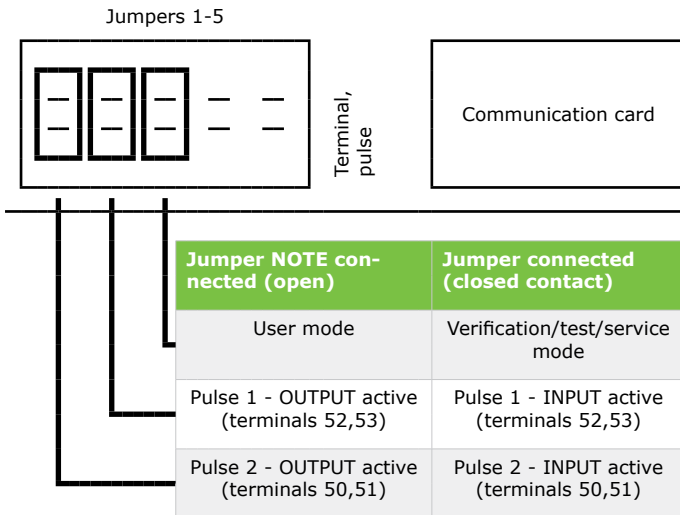

Checking installation & configuration

After installing the heat meter, flow the fluid through the flow sensor. Measured values should be displayed on the display if the heat meter (calculator, flow and temperature sensor) is correctly installed. If the measured values are not displayed correctly, it is necessary to check the installation.

Sealing after installation

If the meter is to be used for billing, it must be sealed so that, after installation, it cannot be disassembled, moved or changed without obvious damage to the meter or seal.

See section "Labeling and sealing" later in this documentation for more information.

Electrical installation

Calculator's terminals

Terminal	Connection
5	Hot temp sensor (T1)
6	Hot temp sensor (T1)
7	Cold temp sensor (T2)
8	Cold temp sensor (T2)
50	Pulsin/output 2 - GND
51	Pulsin/output 2 (volume in test mode)
52	Pulsin/output 1 - GND
53	Pulsin/output 1 (energy in test mode)

Extra terminals

Terminal	Connection
24	M-bus (on M-bus-module)
25	M-bus (on M-bus-module)
20	CL+ (on CL-module)
21	CL- (on CL-module)

Temperature sensor connection

With factory mounted sensors, it is forbidden to split, shorten or extend the cables. If screw terminals are available on the calculator, cables, during commissioning, may temporarily be disconnected from the terminals and reconnected.

Connection of the customer's temperature sensor

If sensors other than those supplied with the meter are used, type-approved and matching pairs of temperature sensors with two-wire connection must be used.

Before installation, check that the temperature sensors are paired.

Using a pliers, remove the protective balls from the holes 1 and 2 of the cable entry on the left side of the calculator.

Pull the cable to the flow temperature sensor T1 through the hole 1 and the cable to the return temperature sensor T2 through the hole 2.

Use two-wire connection for the temperature sensors (see electrical diagram above).

Installation of additional communication modules

In the lower right corner of the calculator, communication modules can be mounted and connected. The module is fastened with two screws.

Using a pliers, remove the protective ball from a non-used cable entry into the calculator. Pull the cable through the hole and attach as shown below.

Connect a cable to the module according to the instructions for each module.

External power supply

24V module and 230V unit are available for external power supply. See separate documentation.

Operating instructions

Display management is done through the button on the front of the calculator.

Screen Features

The meter has an 8-character LCD with symbols for various parameters, units and operating modes.



Flow symbols

- Flow, forward (correct flow direction)
- Flow, backwards
- No flow registered

Menu structure

User menu in normal mode

Long press of the button (> 3 sec) changes menu.

Short press of the button (<3 sec) changes objects down.

Measurement 1.2, or if there are errors, info code 1.1 is displayed when the button is not pressed for 60 seconds.

See table below for explanation. Please note that this is a complete list. Specific meters may not show all of these parameters.



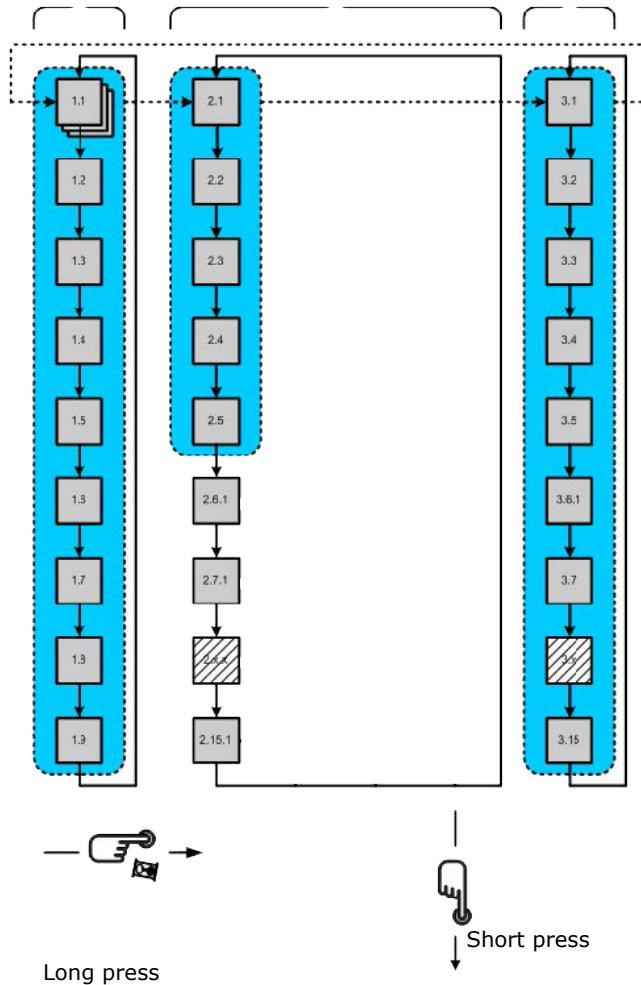

INT (integral) Main menu BIL (Billing) Log screen menu INF (Information) Instant menu



Menu

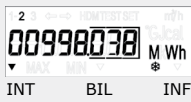
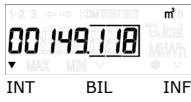

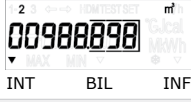
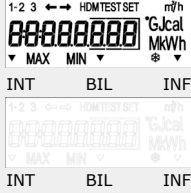

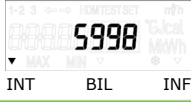
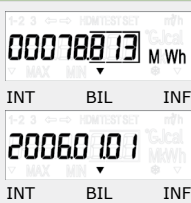
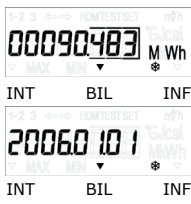
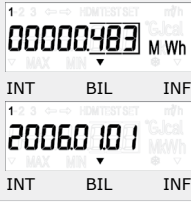
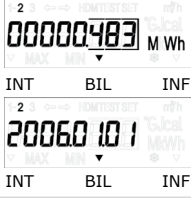

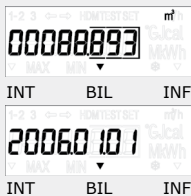
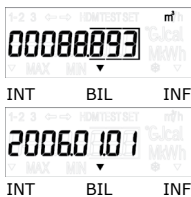
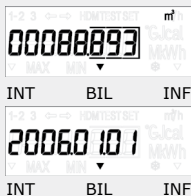
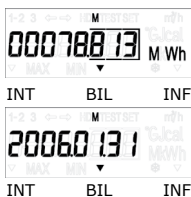
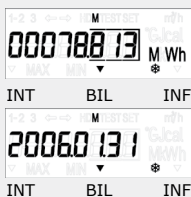
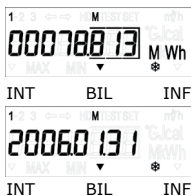
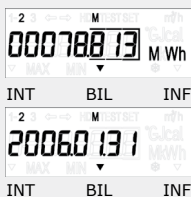
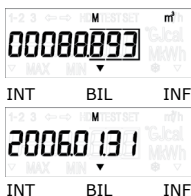
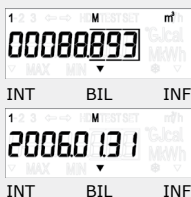

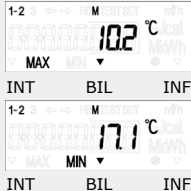
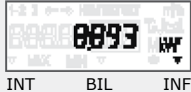

Note that this is complete menu structure. For a specific meter, some parts may be disabled.



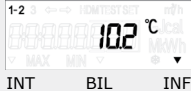







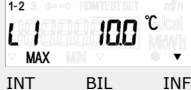

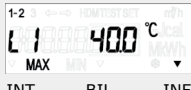

ID	Parameter	Value	Description
MAIN MENU (INT) - INTEGRAL PARAMETERS:			
1.1	Infocode with time stamp (only shown in case of error)	 	<p>All three values shown with 1 second interval.</p> <p>Error in calculator Error in temp sensor 2 Error in temp sensor 1 Error in flow sensor</p> <p>Detailed description - see <i>Infocodes / alarm</i></p>
1.2	Energy for heating	 INT BIL INF	
1.3	Energy for cooling	 INT BIL INF	Shown only for combined heating/cooling meters.
1.4	Totalizer energy for tarif 1	 INT BIL INF	"Snowflake" indicates that the tariff is linked to the meter of cooling energy.



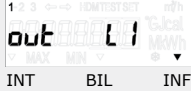

ID	Parameter	Value	Description
1.5	Totalizer energy for tarif 2		"Snowflake" indicates that the tariff is linked to the meter of cooling energy.
1.6	Volume		
1.7	Totalizer pulse input 1		The additional flow sensor can be connected to a pulse input 1.
1.8	Totalizer pulse input 2		The additional flow sensor can be connected to a pulse input 2.
1.9	Display test		Changes every 1 sec.
1.10	Working hours without a energy calculation error		
1.11	Customer number		Corresponds to a wire transmission via MBus protocol.
1.12	Control number		
LOGGERMENU (BIL) - BILLING DATA:			
2.1	Energy (heating) during a specific day, with timestamp		Changes every 1 sec.
2.2	Energy (cooling) during a specific day, with timestamp		Only shown in meters with cooling. Changes every 1 sec.
2.3	Tarif 1 during a specific day, with timestamp		Changes every 1 sec.
2.4	Tarif 2 during a specific day, with timestamp		Changes every 1 sec.

ID	Parameter	Value	Description
2.5	Volume during a specific day, with timestamp		Changes every 1 sec.
2.6	Pulse input 1 during a specific day, with timestamp		Changes every 1 sec.
2.7	Pulse input 2 during a specific day, with timestamp		Changes every 1 sec.
2.8	Energy (heating) during a specific day last month, with timestamp		Datum enligt kunds önskemål. Om 31 väljs, visas sista dagen i månaden. Registrerad tid: 23:59:59. Changes every 1 sec.
2.9	Energy (cooling) during a specific day last month, with timestamp		Changes every 1 sec.
2.10	Tarif 1 during a specific day last month, with timestamp		Changes every 1 sec.
2.11	Tarif 2 during a specific day last month, with timestamp		Changes every 1 sec.
2.12	Volume during a specific day last month, with timestamp		Changes every 1 sec.
2.13	Pulse input 1 during a specific day last month, with timestamp		Changes every 1 sec.

ID	Parameter	Value	Description
2.14	Pulse input 2 during a specific day last month, with timestamp		Changes every 1 sec.
2.15	Max power last month, with timestamp		Changes every 1 sec.
2.16	Min power (or max cooling power) last month, with timestamp		Changes every 1 sec.
2.17	Max flow rate last month, with timestamp		Changes every 1 sec.
2.18	Max temperature in supply last month, with timestamp		Changes every 1 sec.
2.19	Max temperature in return last month, with timestamp		Changes every 1 sec.
2.20	Max temperature difference last month, with timestamp		Changes every 1 sec.
2.21	Min temperature in supply last month, with timestamp		Changes every 1 sec.
2.22	Min temperature in return last month, with timestamp		Changes every 1 sec.

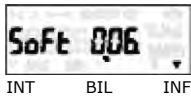
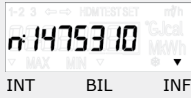
ID	Parameter	Value	Description
2.23	Min temperature difference last month, with timestamp		Changes every 1 sec.
MOMENTANMENY (INF) - MOMENTANA VÄRDEN:			
3.1	Thermal power		
3.2	Flow rate		
3.3	Temperatures in supply pipe		
3.4	Temperature in return pipe		
3.5	Temperature difference		
3.6*	Next date for battery change		
3.7*	Date		
3.8*	Time		
3.9*	Yearly billing date		
3.10*	Monthly billing date		

ID	Parameter	Value	Description
3.11*	Tarif 1	<p>Tariff 1, at T1-T2 < 10,0°C</p>  <p>INT BIL INF</p> <p>Or > 10,0°C</p>  <p>INT BIL INF</p> <p>Or between 10,0...40,0°C</p>  <p>INT BIL INF</p>  <p>INT BIL INF</p> <p>Or in time interval in hours (00...24h)</p>  <p>INT BIL INF</p> <p>Or tariff activated by pulse input:</p>  <p>INT BIL INF</p>	<p>It is possible to choose:</p> <p>One of the measured parameters, 1st or 2nd pulse input (if it is configured as an input), one of the temperature or the temperature difference.</p>
3.12*	Tarif 2	See menu 3.11 but with L2 instead of L1.	See menu 3.11.
3.13*	Pulse in/output 1 configuration	<p>Input:</p>  <p>INT BIL INF</p> <p>Input (tariff activated):</p>  <p>INT BIL INF</p> <p>Output: energy, volume</p>  <p>INT BIL INF</p> <p>Tarif</p>  <p>INT BIL INF</p>  <p>INT BIL INF</p> <p>Tarif mode:</p>  <p>INT BIL INF</p>	<p>Inputs:</p> <p>Can be configured only for a quantity of water. Maximum pulse resolution is displayed 0.00001 m3.</p> <p>Outputs:</p> <p>Can be configured for a quantity of water (m3), for heating (In a shown case) / cooling (additional snowflake is displayed) energy or to one of tariffs.</p>
3.14*	Pulse in/output 2 configuration	See menu 3.13 but with "2" instead of "1".	See menu 3.13.
3.15	Type of heat-conveying liquid	 <p>INT BIL INF</p>	Type of heat-conveying liquid: "---" (crosses) - water
3.16	Pressure value for energy calculations	 <p>INT BIL INF</p>	"160E4"-corresponds to the pressure 1.6 MPa.
3.17*	Customer number	 <p>INT BIL INF</p>	Are transferred on telegram Mbus.

ID	Parameter	Value	Description
3.18	Software version		
3.19	Serial number		
3.20*	M-bus address		
3.21	Working hours without a power calculation error		
3.22	Battery operation time		

Note:

Values of the parameters marked with "*" and energy measurement units (kWh, MWh, Gcal or GJ) can be modified by installing a meter. Replacement is possible via optical interface and in conjunction with the special configuration programme in a test mode, when jumper is set.

In the same way it is possible to switch off indication of irrelevant parameters.

Test/verification mode

Menu

The menu structure in the test mode as below.

Long press of the button (> 3 sec) changes menu.

Short press of the button (<3 sec) changes objects down.

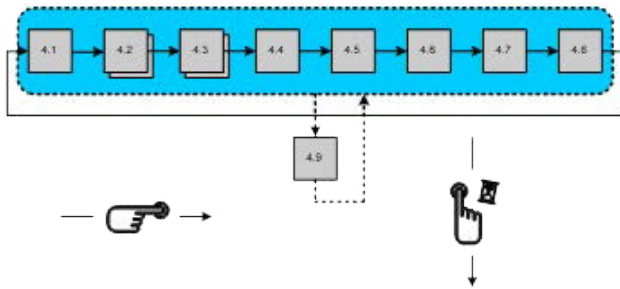

ID	Parameter	Value	Description
4.1	High resolution energy		Updated every 1 sec.
4.2	High- resolution volume		Updated every 1 sec.
4.3	Number of pulses of pulse input 1		
4.4	Number of pulses of pulse input 2		
4.5	Temperature of heat conveying liquid in flow pipe		
4.6	Temperature of heat conveying liquid in return pipe		
4.7	Temperature difference		
4.8	Activation of flow simulation		<p>During test, the value of flow is constantly displayed.</p> <p>After the ending of test, the values of energy and quantity of a liquid are registered in memory till the successive test or before following actuating of the flow simulation.</p>
4.9	High resolution flow rate		

Connections in the test / verification mode

The 2-line 10-pole connection in the calculator, between the terminals for the temperature sensors and the pulse in/outputs, activates the test / validation mode.

See picture.

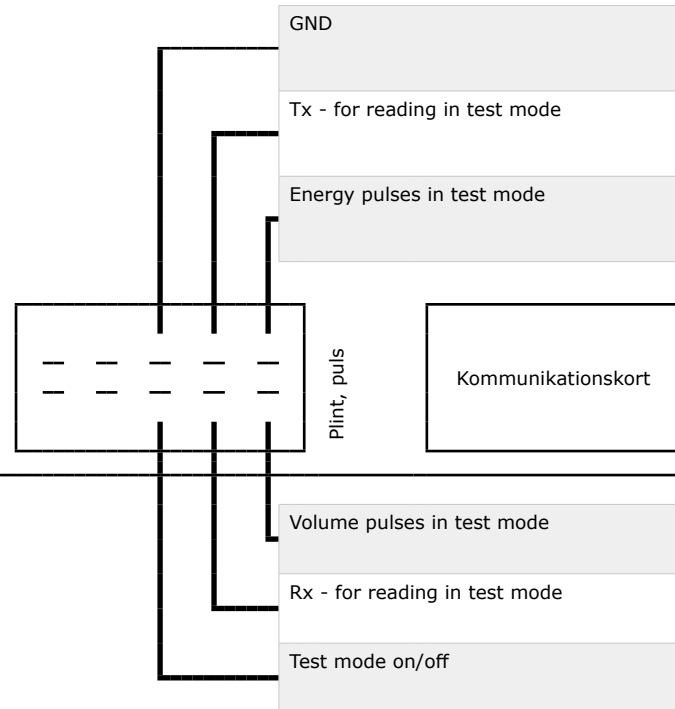

In test mode, it is possible to achieve exact results at short intervals.

To activate test / verification mode, jumper 3 must be mounted (see Setting the Jumpers J).

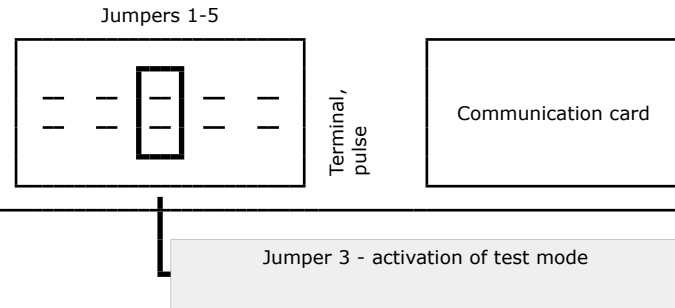

Do not turn off the meter in this position.

When jumper 3 is mounted, the unit assumes the test position. "TEST" appears on the display, the calculation process is stopped and all integrated parameter values are stored in memory. After returning to normal mode, the original values from before the test are displayed again.

The resolution of the measured values in the test / validation mode as below.

Energy unit	kWh/MWh	GJ	Gcal
Resolution, energy	000000,01 Wh	0000000,1 kJ	0000000,1 kcal
Resolution, volume	00,000001 m ³		

Pulse values in test / verification mode as below.

Permanent flow rate qp	Pulse value volume (l/p)	Pulse value energy		
		kWh/MWh	GJ	Gcal
0,6	0,002	0,1 Wh/p	0,5 kJ/p	0,1 kcal/p
1,0	0,002	0,2 Wh/p	1 kJ/p	0,2 kcal/p
1,5	0,004	0,2 Wh/p	1 kJ/p	0,2 kcal/p
2,5	0,005	0,5 Wh/p	2 kJ/p	0,5 kcal/p
3,5	0,02	1 Wh/p	5 kJ/p	1 kcal/p
6,0	0,02	1 Wh/p	5 kJ/p	1 kcal/p
10	0,05	2 Wh/p	10 kJ/p	2 kcal/p
15	0,05	5 Wh/p	20 kJ/p	5 kcal/p
25	0,05	5 Wh/p	20 kJ/p	5 kcal/p
40	0,2	10 Wh/p	50 kJ/p	10 kcal/p
60	0,2	10 Wh/p	50 kJ/p	10 kcal/p

Exit test / validation mode

Remove jumper 3 to exit test mode and return to normal mode. After leaving the test mode, previously saved values are displayed.

Verification

Metrological control of the parameters of the heat meters is performed according to the requirements specified in EN 1434-5.

Overflow

At flow $q < 1.2 * q_s$ (maximum flow) = linear flow.

At flow $q > 1.2 * q_s$ (maximum flow) = constant flow ($q = 1.2 * q_s$ is used for energy calculation). Error message 4 "Flow rate higher than $1.2 * q_s$ " is recorded and alarms all the time it is active.

Info codes / alarms

Info codes can consist of up to 4 characters. Each character has values 0 ... F.

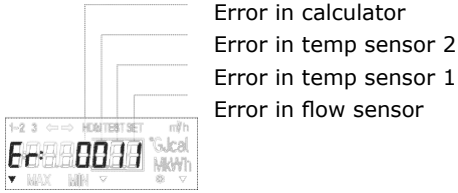

Info code	Explanation
<p>Status of calculator</p> <p>▼</p>	<p>0 - No error, normal operation</p> <p>1 - Warning – ending battery life</p> <p>2 - Temperature difference is greater than the permitted limits</p> <p>4 - Temperature difference is less than the permitted limits</p> <p>8 - Electronics failure</p>
<p>Status of temp sensor 2 (return)</p> <p>▼</p>	<p>0 - No error, normal operation</p> <p>4 - Short circuit</p> <p>8 - Sensor failure (open circuit or short circuit)</p>
<p>Status of temp sensor 1 (supply)</p> <p>▼</p>	<p>0 - No error, normal operation</p> <p>4 - Short circuit</p> <p>8 - Sensor failure (open circuit or short circuit)</p>
<p>Status of flow sensor</p> <p>▼</p>	<p>0 - No error, normal operation</p> <p>1 - No signal, flow sensor is empty</p> <p>2 - Flow flows in an reverse direction</p> <p>4 - Flow rate greater than 1.2·qs (are displayed q=1,2qs)</p> <p>8 - Electronics failure</p>

Active info codes are added and displayed simultaneously, even if it is more than one error.

3 - corresponds to error 2 + 1

5 - corresponds to error 4 + 1

7 - corresponds to error 4 + 2 + 1

9 - corresponds to error 8 + 1

A - corresponds to error 8 + 2

B - corresponds to error 8 + 2 + 1

D - corresponds to error 8 + 4 + 1

E - corresponds to error 8 + 4 + 2

F - corresponds to error 8 + 4 + 2 + 1

When any info code is ≥ 8 , measurement of energy and volume stops. Operating time without error stops counting.

When the flow sensor shows error 4 during operation, the time in the register is counted "flow over $q > 1.2 \cdot q_s$ "

Technical data

Accuracy class	2 according LST EN1434-1:2007
Units, energy	kWh, MWh, GJ, Gcal
Max value, power	2,63 MW

Flow sensors can be supplied for thread connection (up to qp 10 m³ / h) or flange.

Technical data for the flow sensor is presented in the following table.

Flow measurement

The meters are provided with dynamic measuring range R100 and R250, i.e. $q_p = q_i \times 100$ or $q_p = q_i \times 250$. R250 is only available for qp 1.5, 2.5, 6.0 and 15 m³ / h.

Flow rate (m ³ /h)				Connection	Length L (mm)	Nom. pressure PN (bar)	Pressure drop at qp (kPa)	Weight (kg)
Nom. qp	Max qs	Min qi*	Start					
0,6	1,2	0,0060	0,003	G20/G¾"	110	16	7,0	1,0
	1,2	0,0060	0,003	G25/G1" (and DN20)	190	16	0,90	1,3
1,5	3,0	0,015/0,0060	0,003	G20/G¾"	110	16	17,1	1,0
	3,0	0,015/0,0060	0,003	G25/G1" (and DN20)	190	16	5,8	1,3
2,5	3,0	0,015	0,005	G25/G1"	130	16	7,2	1,3
	5,0	0,025/0,010	0,005	G25/G1"	130	16	19,8	1,3
3,5	5,0	0,025/0,010	0,005	G25/G1" (and DN20)	190	16	9,4	1,3
	7,0	0,035	0,017	G32/G1¼"	260	16	4,0	3,9
6,0	12	0,060/0,024	0,012	G32/G1¼" (and DN25)	260	16	10	3,9
10	20	0,040/0,10	0,02	G50/G2" (and DN40)	300	16	18	4,0
15	30	0,15/0,060	0,03	DN50 flange	270	16	12	6,8
25	50	0,25/0,10	0,05	DN65 flange	300	16	20	13
40	80	0,40/0,16	0,08	DN80 flange	300	16	18	14
60	120	0,60/0,24	0,12	DN100 flange	360	16	18	19

*) Minimum values are R100 / R250

Temperature limits for the liquid

- For flow sensors qp 2.5 m³ / h 5 ° C 130 ° C
- For flow sensors qp ≥ 3.5 m³ / h 10 ° C 130 ° C

Note: For liquid temperature below 90 ° C, the integrator can remain on the flow sensor or be mounted on the wall. For liquid temperature above 90 ° C, the integrator must be mounted on the wall.

Connection cable length between the integrator and the flow sensor 1.2 m.

Maximum working pressure 16 bar (PN16).

The meter's behavior, when the flow rate exceeds the maximum flow qs:

- Linear at flow rate up to $q = 1.2 \cdot q_s$
- Constant at flow rate $q > 1.2 \cdot q_s$ ($q = 1.2 \cdot q_s$ is assumed for heat energy calculation). The error message "Maximum allowable flow rate value is exceeded" is displayed

Temperature measurement

Temperature range, calculator	0°C 180°C
Temperature difference range	2K 150K (eller 3K 150K)
Temperature sensors	
Platinum resistance temperature sensors Pt500	Pt 500 (according EN60751 and paired according EN1434 and MI004 in directive 2014/32/EU)
Alternative temperature sensors	Pt1000 (on request)
For threaded meters G20, G25 and G32	Direct mounted short sensors type DS according LST EN1434-2

For all other connections	Pocket mounted longer sensors type PL according LST EN1434-2
Cable lengths for 2 wire temperature sensors	
Sensor type DS (see above)	1.5m standard (2.5 or 5m on request)
Sensor type PL (see above)	Cable length depending on meter size (3 up to 10m)

LCD Display

The device is equipped with 8-digit LCD (Liquid Crystal Display) with special symbols to display parameters, units of measurement and operating modes.

The following information can be displayed: integrated and instantaneous measured parameters, and archive data and device configuration.

Display resolution, depending on permanent value flow rate, is provided in the following table.

Permanent flow rate qp	< 6 m ³ /h	≥ 6 m ³ /h
Resolution volume, m ³	00000,001	00000,001
Resolution energy, kWh (MWh)	0000000,1 kWh	00000,001 MWh
Resolution energy, Gcal	00000,001 Gcal	00000,001 Gcal
Resolution energy, GJ	00000,001 GJ	00000,001 GJ

Register and data logger

Every hour, day and month, measured values are saved in the meter's memory. All logged data can be read using remote reading. Only data loggers for monthly parameters can be seen on the display. The following values are logged in the meter's memory daily, weekly and monthly:

1. Total energy
2. Total cooling energy
3. Total energy in tariff 1
4. Total energy in tariff 2
5. Total fluid volume
6. Total pulse value in pulse input 1
7. Total pulse value in pulse input 2
8. Maximum power for heat and date
9. Maximum power for cooling and date
10. Maximum flow value and date
11. Maximum flow temperature value for the fluid and date
12. Maximum value of the return temperature for the liquid and date
13. Minimum flow temperature value for the fluid and date
14. Minimum value of return temperature for the liquid and date
15. Minimum temperature difference and date
16. Average flow temperature of the liquid
17. Mean return temperature of the liquid
18. Operating time without error
19. Total field time
20. Time when the flow exceeded 1.2 q_s
21. Time when flow rate was lower than q_i

Data logger capacity

Hourly values	1480 hours
Daily values	1130 days
Monthly values	36 months

Archived data storage - at least 36 months.

Storage time of measured values, even if the unit is disconnected from the power supply - at least 15 years.

Mechanical data

Outer dimensions, calculator	117 mm x 44 mm x 89,5 mm
Outer dimensions, flow sensor	See separate section

Environmental conditions

Environmental class	Class C acc. EN1434 (industry)
Ambient temperature, calculator	+5°C 55°C (condensation free, indoor)
Ambient temperature, flow sensor	-30°C 55°C (condensation free, indoor)
Relative humidity	<93%
Mechanical class	M1
Electromagnetic class	E2
Protection class, calculator	IP65
Protection class, flow sensor	IP65 (IP67 on request)

Pressure drop

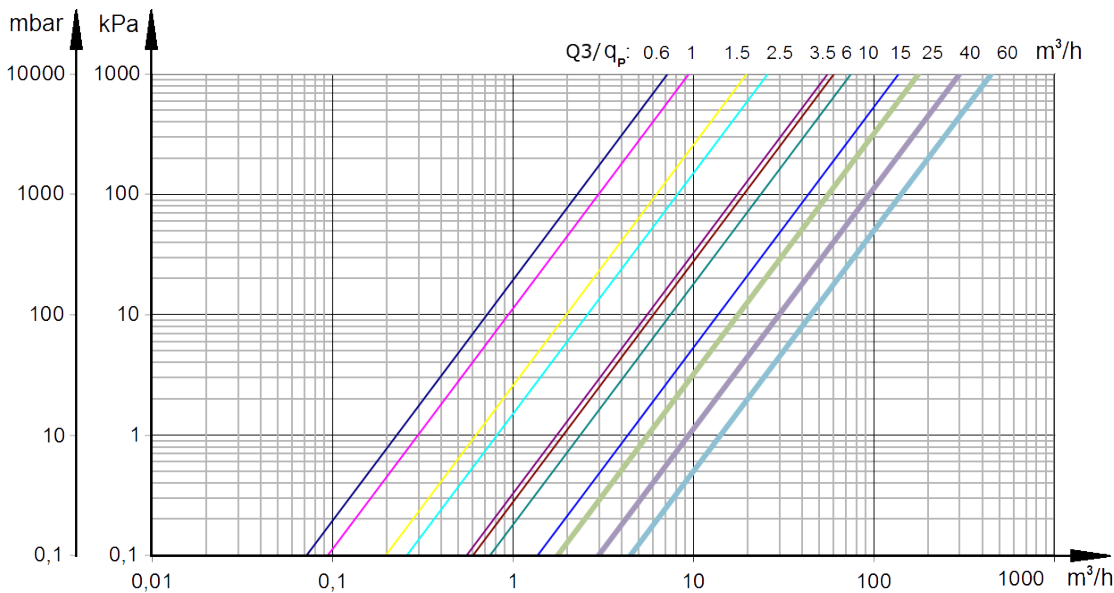

Accuracy

Error tolerance according EN 1434 class 2

Power supply

Internal battery

2 type AA 3.6VDC 2.4 Ah Lithium battery (Li-SOCL2).
Designed to last at least 11 years.

24V module

12 ... 42 VDC or 12 ... 36 VAC 50 / 60Hz max 10mA + internal battery backup (AA 3.6VDC 2.4 Ah Lithium battery (Li-SOCL2)).
The power supply module replaces one battery.

230V unit (external)

230VAC (+ 10 / -30%) 50/60 Hz, approx. 10mA in.
12VAC 40mA (max) out.

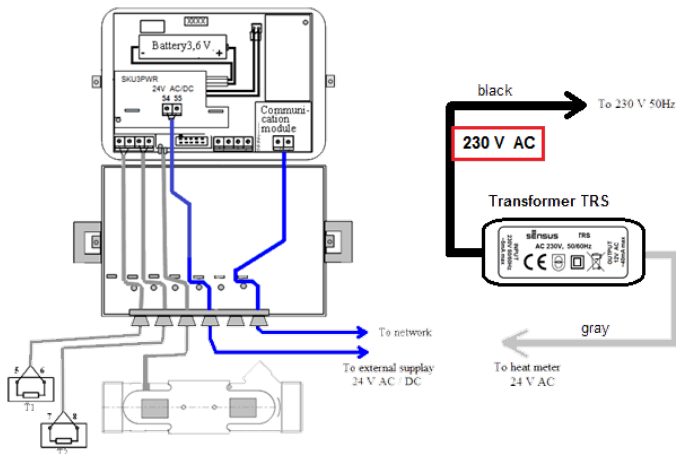

Remote reading

Optical interface can be used for reading data from the meter. The optical head is placed on the meter and connected to RS-232 or USB.

In addition to remote reading via IR, it is also possible to use two pulse outputs, or one of the following communication modules.

Wired communication:

- M-Bus (default)
- Modbus RTU
- BACnet TCP
- LON
- CL module (current loop)

Wireless communication:

- Lora
- wireless M-bus T1 OMS
- wireless M-bus S1 (and Axioma bi-directional radio)

All modules have separate documentation. The modules can also support mounting in other of our meters.

Our meters are normally backwards and forwards compatible with old and new modules.

Optical interface

Integrated in the front panel of the calculator. It is used for data reading via the M-bus protocol and parameterization of the meter.

The optical interface is activated only after pressing the button and automatically shuts off after 5 minutes after the last key press or after the data transfer is completed via the interface.

M-bus

The cards use 1.5mA (1 M-bus load). See separate documentation.

Lora

Separate documentation is available. The meter can be connected to any network server and application server. Parameter list can be obtained on request.

LoRa meters can be remotely programmed with MAC commands. Contact Ambiductor for more information.

Pulse outputs

The pulse outputs are active when the jumpers of the connector (J) are open (see Setting the Jumpers J)

No communication interface affects measurement values and their calculation, and can therefore be replaced by another type without removing the seal.

Data collection from meters can be done via PC, modem, GSM, broadband etc.

Number of possible outputs	2 pcs (OB normal mode, OD test mode)
Pulse type	Open collector (transistor), permitted current up to 20 mA, voltage up to 50V
Pulse length	100 ms - in normal operating mode, 1.6 ms - in test mode

Pulse values (energy and volume) of pulse output device in operating mode according to the table below:

Energy pulse output #1			
Energy units	kWh, MWh	GJ	Gcal
Pulse value, energy	1 kWh/p	0,005 GJ/p	0,001Gcal/p

Energy pulse output #2		
Permanent flow rate qp m3/h	0,6...6,0	10...60
Pulse value, flow rate	1 l/p	10 l/p

Pulse inputs

The pulse inputs are active when the jumpers of the connector (J) are closed (see Setting the Jumpers J)

Number of pulse inputs	2
Measuring units	m3
Pulse value	Programmable
Pulse type	IB acc. LST EN1434-2
Maximum frequency of pulses	3 Hz
Max voltage on pulses	3,6 V

Bus communication limitation

The total working time for serial communication interfaces (to protect the battery from premature discharge) is limited to 130 minutes per month. The remaining time for communication is stored in the calculator. The interface is blocked after reaching the limit and only after the start of the next hour, the new time limit on communication will be given (to 11 seconds for each subsequent hour).

To release the restriction, connect external power supply and follow the instructions at www.ambiductor.se/support.

This requires connection via m-bus or optical IR port.

Marking and sealing

Marking

The calculator

The following information can be found on the front of the calculator:

- Manufacturer's brand
- Type of meter
- Serial number
- Year
- Approval number
- Temperature range
- Temperature difference range
- Accuracy class
- Environmental class according to LST EN1434-1,
- Electromagnetic and mechanical environmental class
- Protection
- Type of temperature sensor
- Installation page (supply or return line)
- Flows (Qi, qp, Qs)
- Maximum temperature range for flow sensor
- Maximum permissible working pressure
- Nominal pressure
- Voltage level for power supply

Terminal numbers are indicated next to the terminals

Flow sensors

There is the following information on the flow sensor:

- Nominal diameter
- Arrow for indicating a flow direction

Sealing

The seal of the manufacturer

- A warranty designation on a screw in the enclosure's enclosure (see below).
- Sealing the screws on the protective cover for the flow sensor (sticker or wire seal as shown below).

Valideringsplombering

- A seal on a screw in the enclosure's enclosure (see below).
- Seals on the screws in the flow sensor housing (sticker or wire seal as shown below).

Monteringsplombering

- Sealing thread between the upper and lower part of the enclosure's enclosure (see below)
- Seal tube for temperature sensor (see below).

The meter must be sealed to ensure that it is not possible to disassemble, remove or change the meter without apparent damage to the meter or seal after commissioning.

Sealing of calculator

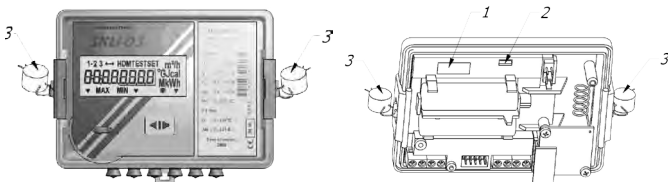

Explanations:

1. Verification seals
2. Factory seals
3. Mounting seals

Seals on flow sensors

DN15...20; L=110mm

DN15...20; L=130mm

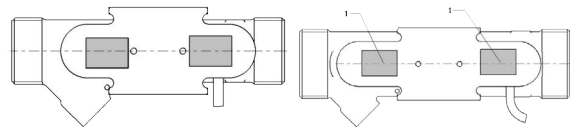

DN25

DN40 thread

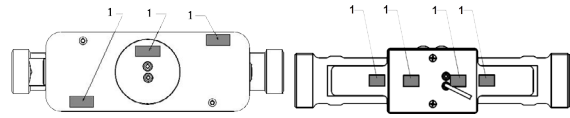

DN 40 flange

DN50 flange

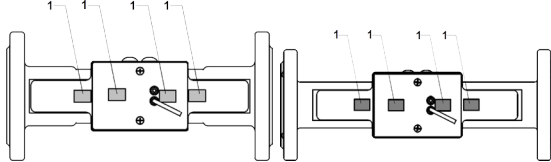

Seals on temp sensor PL (dip tube)

At 45 ° inclination

Perpendicular to pipes

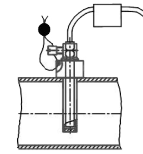
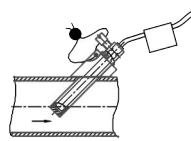

Seals on temp sensor DS (direct)

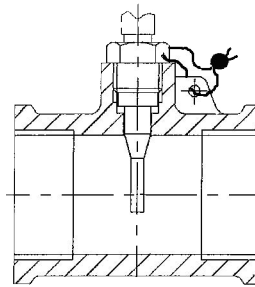

Dimensions and connections

Dimensions calculator for HEAT 1

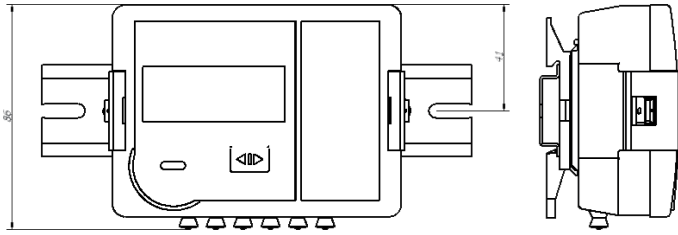

Dimensions HEAT 1 DN15 (G20 / G3/4")

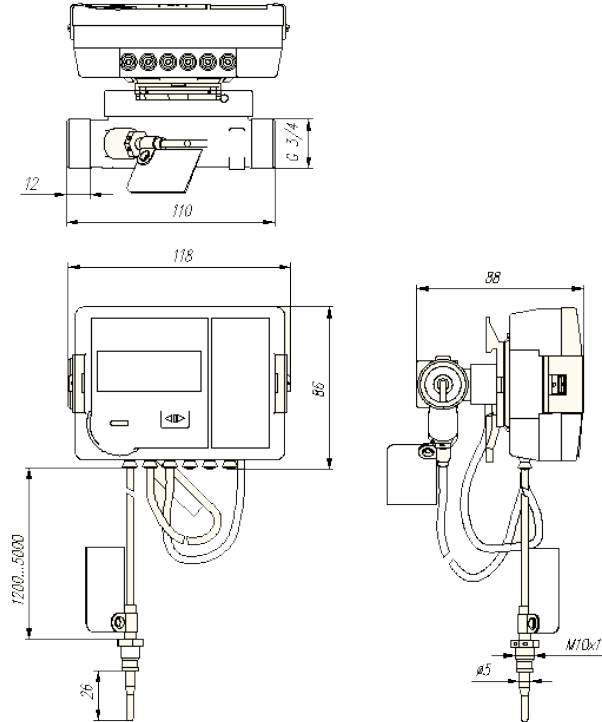

Dimensions HEAT 1 DN20 (G25 / G1") 130mm

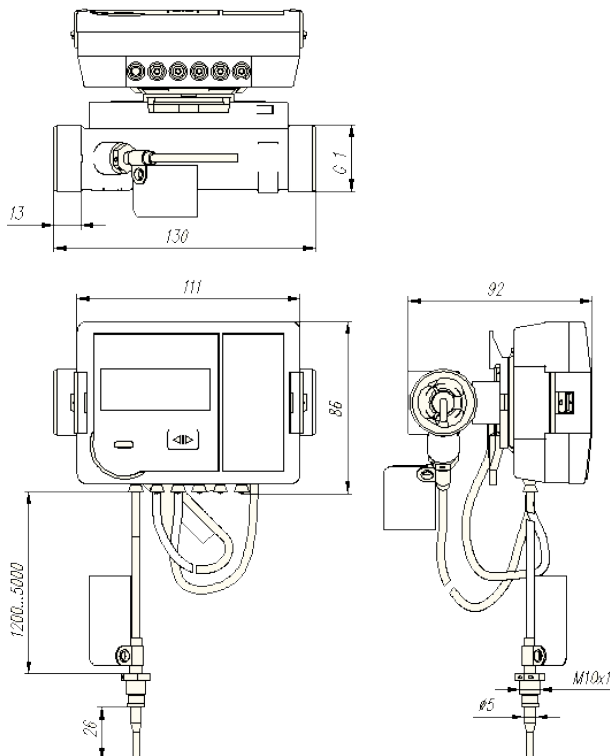

Dimensions HEAT 1 DN20 (G25 / G1") 190mm

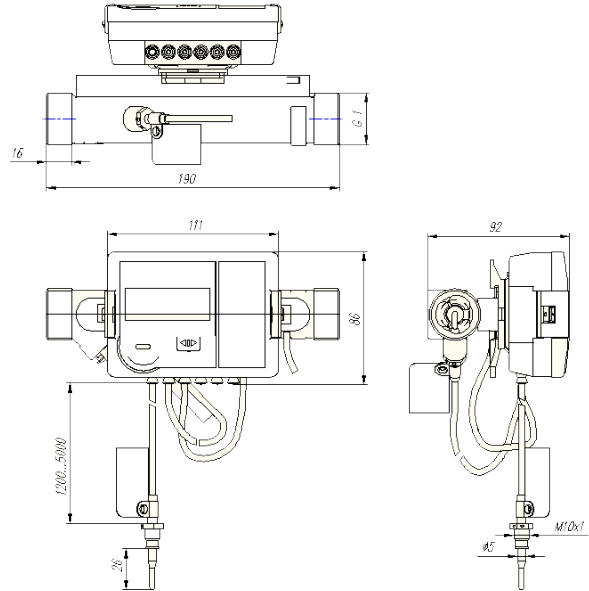

Dimensions HEAT 1 DN20 flange

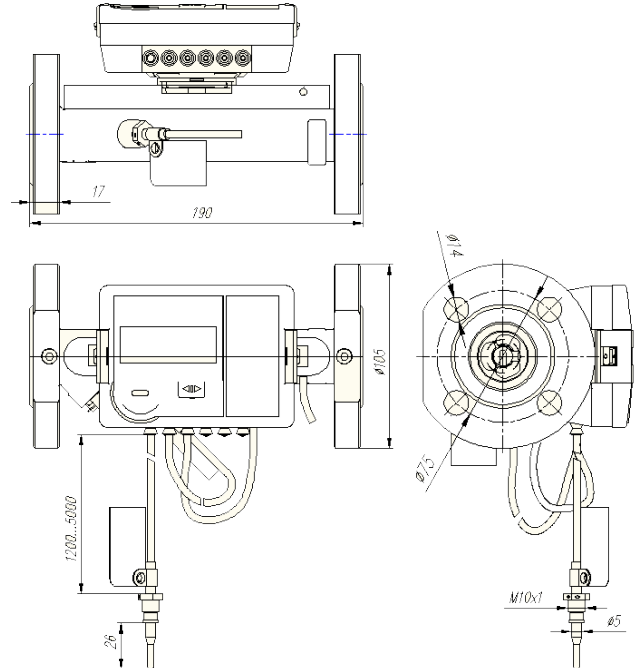

Dimensions HEAT 1 DN25 (G32 / G1 1/4")

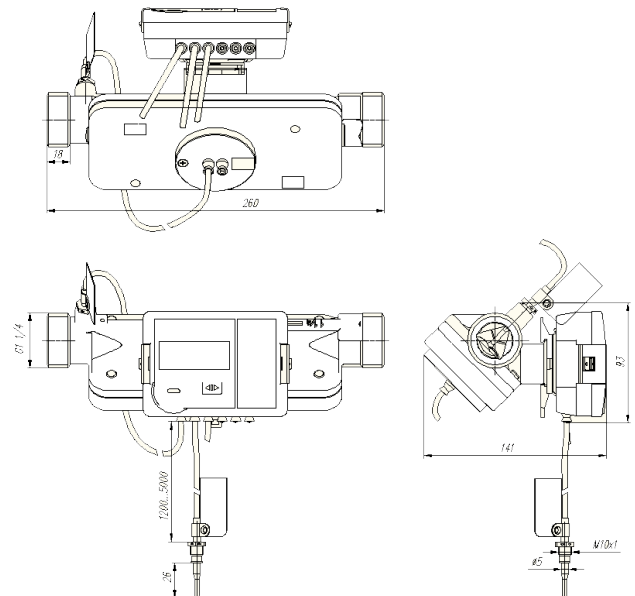

Dimensions HEAT 1 DN25 flange

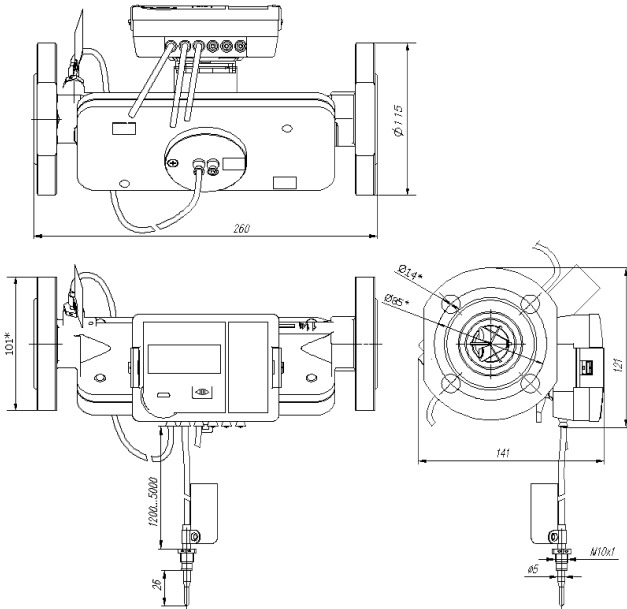

Dimensions HEAT 1 DN50 flange

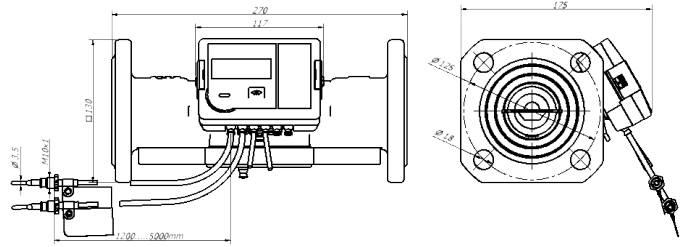

Dimensions HEAT 1 DN65 flange

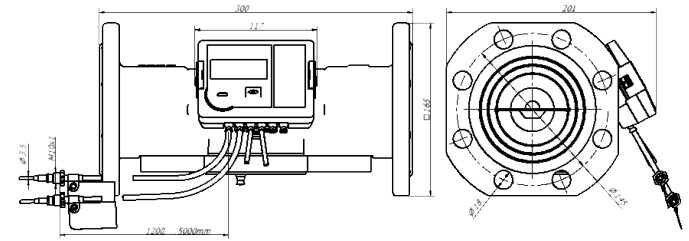

Dimensions HEAT 1 DN80 flange

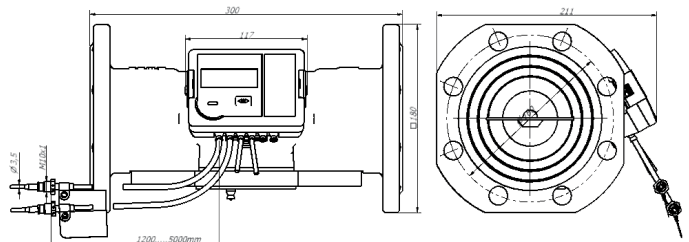

Dimensions HEAT 1 DN100 flange

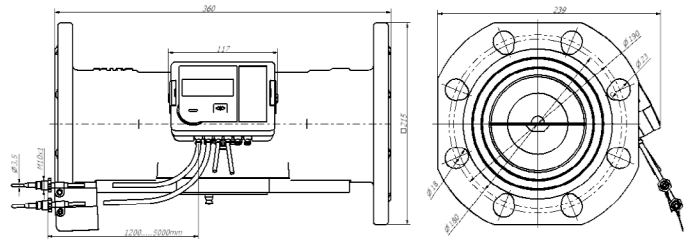

Dimensions HEAT 1 DN40 (G50 / G2")

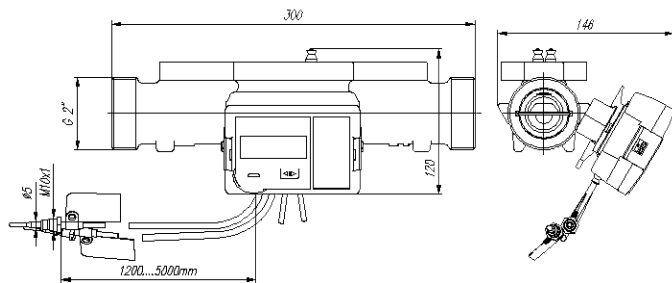

Dimensions HEAT 1 DN40 flange

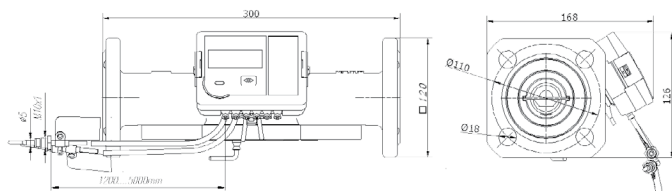

Dimensions HEAT 1 DN40 flange, alternative

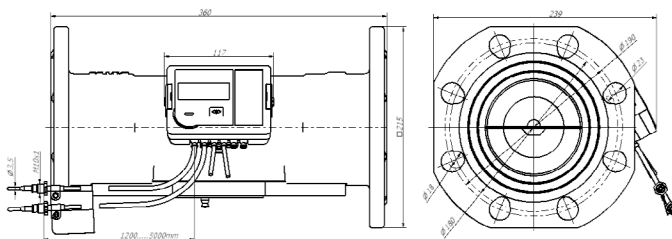

About Ambiductor

Ambiductor focus in the following areas:

- Energy meter
- Water meters
- Oil meters and meters for industrial liquids
- Smart metering and measurement collection
- Lora products

Ambiductor is an engineering company with many years of experience in measurement technology, automation and remote reading. With us, you experience a high level of service and wide range with the possibilities of solving all possible applications.

See instructional videos and assembly guides on www.ambiductor.se/support

Disclaimer!

"If there is any inconsistency between this version and the document in it's original language, the original document will prevail."



Ambiductor AB

Flow & Energy Analysis Systems

Armévågen 61-63
S-187 64 TÅBY
info@ambiductor.se

+46 (0)8 501 676 76
Sweden
www.ambiductor.se